

Features

- Advanced high cell density Trench technology
- Super Low Gate Charge
- Excellent CdV/dt effect decline
- 100% EAS Guaranteed
- Green Device Available

Applications

- High Frequency Point-of-Load, Synchronous Buck Converter for MB/NB/UMPC/VGA
- Networking DC-DC Power System
- LCD/LED Back light

Product Summary



V_{DS}	40	V
I_D (at $V_{GS}=10V$)	60	A
$R_{DS(ON)}$ (at $V_{GS}=10V$)	7.5	m Ω
$R_{DS(ON)}$ (at $V_{GS}=4.5V$)	10	m Ω

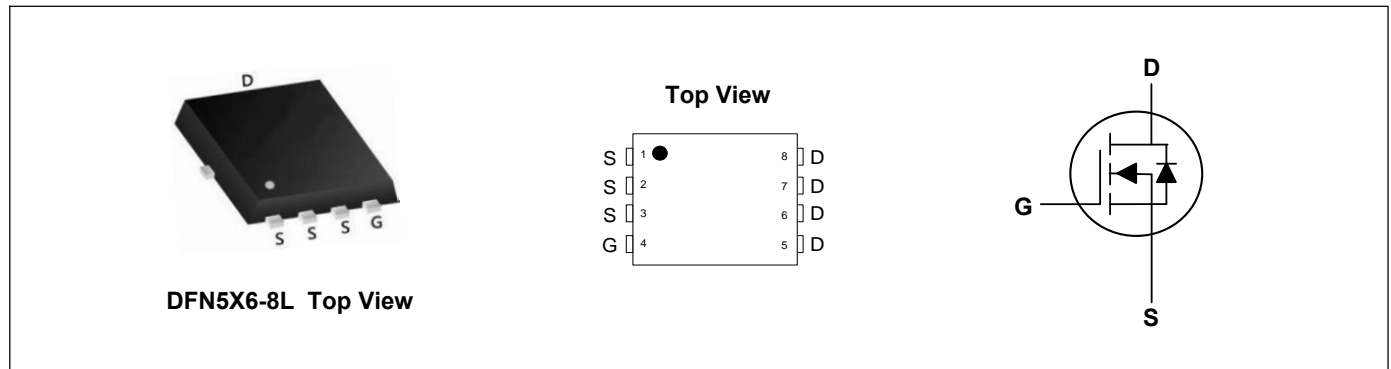

Absolute Maximum Ratings ($T_C=25^\circ C$, unless otherwise noted)

Parameter	Symbol	Rating	Units
Drain-Source Voltage	V_{DS}	40	V
Gate-Source Voltage	V_{GS}	± 20	V
Continuous Drain Current, $V_{GS} @ 10V^1$	$I_D @ T_C=25^\circ C$	60	A
Continuous Drain Current, $V_{GS} @ 10V^1$	$I_D @ T_C=100^\circ C$	45	A
Pulsed Drain Current ²	I_{DM}	120	A
Single Pulse Avalanche Energy ³	EAS	76	mJ
Avalanche Current	I_{AS}	39	A
Total Power Dissipation ⁴	$P_D @ T_C=25^\circ C$	46	W
Storage Temperature Range	T_{STG}	-55 to 150	$^\circ C$
Operating Junction Temperature Range	T_J	-55 to 150	$^\circ C$

Thermal Characteristics

Parameter	Symbol	Typ	Max	Unit
Thermal Resistance Junction-Ambient ¹ (Steady State)	$R_{\theta JA}$	---	62	$^\circ C/W$
Thermal Resistance Junction-Case ¹	$R_{\theta JC}$	---	2.7	$^\circ C/W$

Electrical Characteristics (T_J=25°C, unless otherwise noted)

Parameter	Symbol	Conditions	Min	Typ	Max	Unit
Drain-Source Breakdown Voltage	BV _{DSS}	V _{GS} =0V, I _D =250uA	40	---	---	V
BV _{DSS} Temperature Coefficient	ΔBV _{DSS} /ΔT _J	Reference to 25°C, I _D =1mA	---	0.034	---	V/°C
Static Drain-Source On-Resistance ²	R _{DS(ON)}	V _{GS} =10V, I _D =12A	---	---	7.5	mΩ
		V _{GS} =4.5V, I _D =10A	---	---	10	mΩ
Gate Threshold Voltage	V _{GS(th)}	V _{GS} =V _{DS} , I _D =250uA	1.0	---	2.5	V
V _{GS(th)} Temperature Coefficient	ΔV _{GS(th)}		---	-4.96	---	mV/°C
Drain-Source Leakage Current	I _{DSS}	V _{DS} =32V, V _{GS} =0V, T _J =25°C	---	---	1	uA
		V _{DS} =32V, V _{GS} =0V, T _J =55°C	---	---	5	
Gate-Source Leakage Current	I _{GSS}	V _{GS} =±20V, V _{DS} =0V	---	---	±100	nA
Forward Transconductance	g _{fs}	V _{DS} =5V, I _D =12A	---	39	---	S
Gate Resistance	R _g	V _{DS} =0V, V _{GS} =0V, f=1MHz	---	1.6	---	Ω
Total Gate Charge (4.5V)	Q _g	V _{DS} =20V, V _{GS} =4.5V, I _D =12A	---	18.8	---	nC
Gate-Source Charge	Q _{gs}		---	4.7	---	
Gate-Drain Charge	Q _{gd}		---	8.2	---	
Turn-On Delay Time	T _{d(on)}	V _{DD} =15V, V _{GS} =10V, R _G =3.3Ω, I _D =1A	---	14.3	---	ns
Rise Time	T _r		---	2.6	---	
Turn-Off Delay Time	T _{d(off)}		---	77	---	
Fall Time	T _f		---	4.8	---	
Input Capacitance	C _{iss}	V _{DS} =15V, V _{GS} =0V, f=1MHz	---	2332	---	pF
Output Capacitance	C _{oss}		---	193	---	
Reverse Transfer Capacitance	C _{rss}		---	138	---	

Drain-Source Diode Characteristics

Parameter	Symbol	Conditions	Min	Typ	Max	Unit
Continuous Source Current ^{1,5}	I _S	V _G =V _D =0V, Force Current	---	---	60	A
Pulsed Source Current ^{2,5}	I _{SM}		---	---	120	A
Diode Forward Voltage ²	V _{SD}	V _{GS} =0V, I _S =1A, T _J =25°C	---	---	1	V

Note:

- The data tested by surface mounted on a 1 inch² FR-4 board with 2OZ copper.
- The data tested by pulsed, pulse width ≤ 300us, duty cycle ≤ 2%
- The EAS data shows Max. rating. The test condition is V_{DD}=25V, V_{GS}=10V, L=0.1mH, I_{AS}=39A
- The power dissipation is limited by 150°C junction temperature
- The data is theoretically the same as I_D and I_{DM}, in real applications, should be limited by total power dissipation.

Typical Characteristics

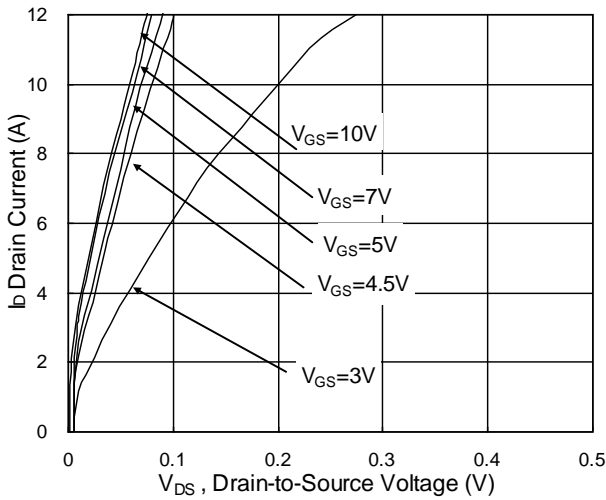

Fig.1 Typical Output Characteristics

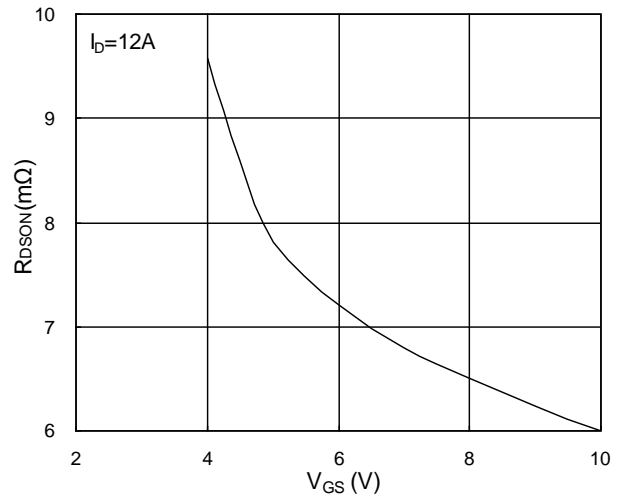

Fig.2 On-Resistance vs. G-S Voltage

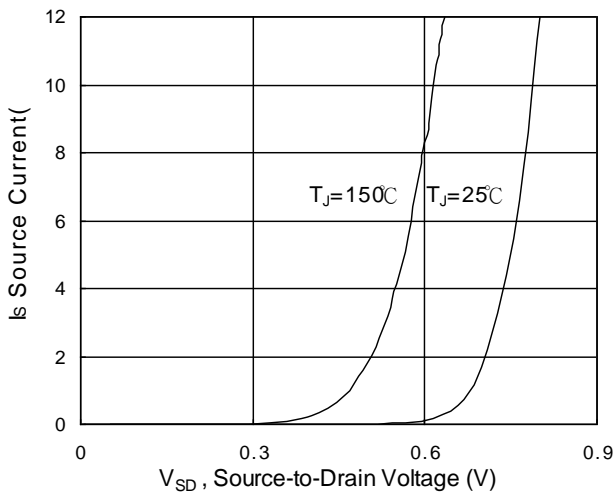

Fig.3 Forward Characteristics of Reverse

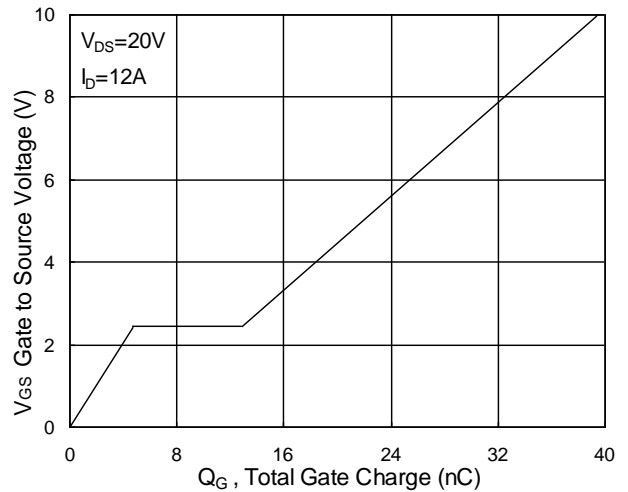

Fig.4 Gate-Charge Characteristics

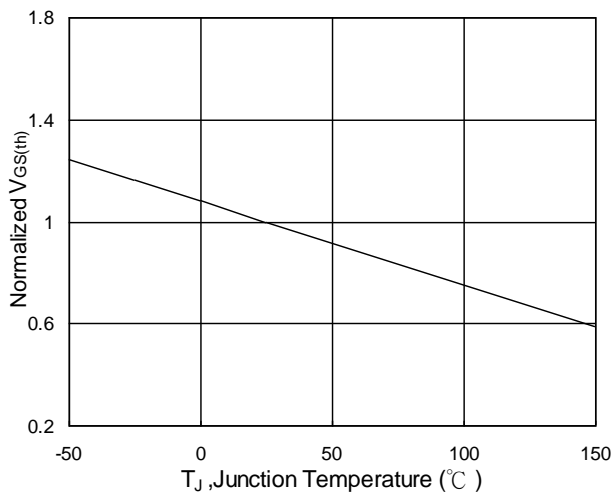

Fig.5 Normalized $V_{GS(th)}$ vs. T_J

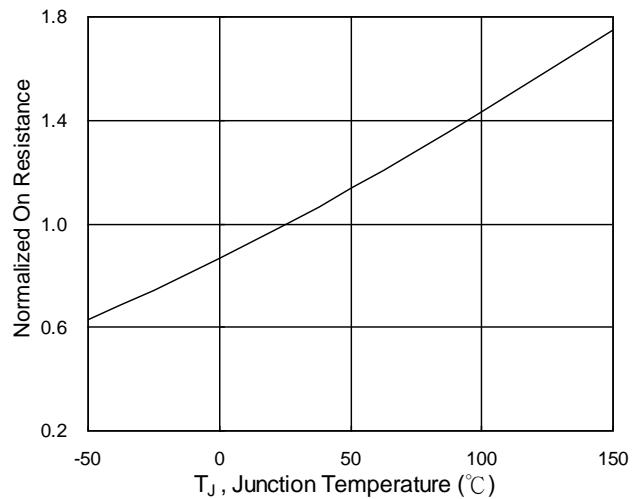

Fig.6 Normalized $R_{DS(on)}$ vs. T_J

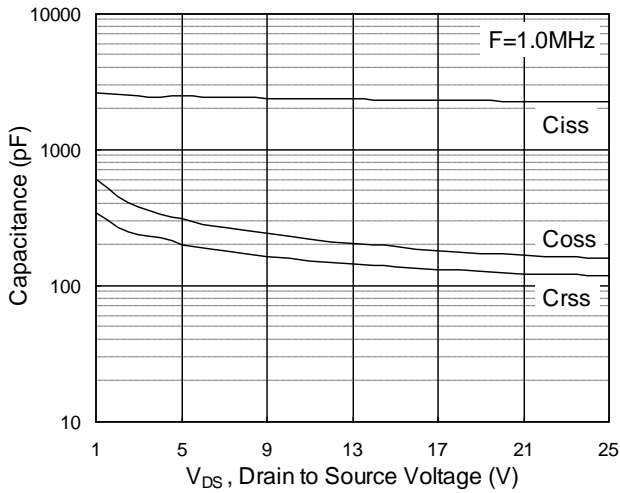

Fig.7 Capacitance

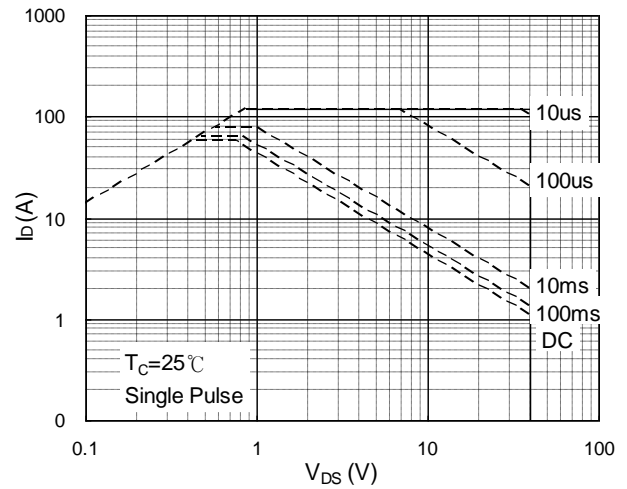

Fig.8 Safe Operating Area

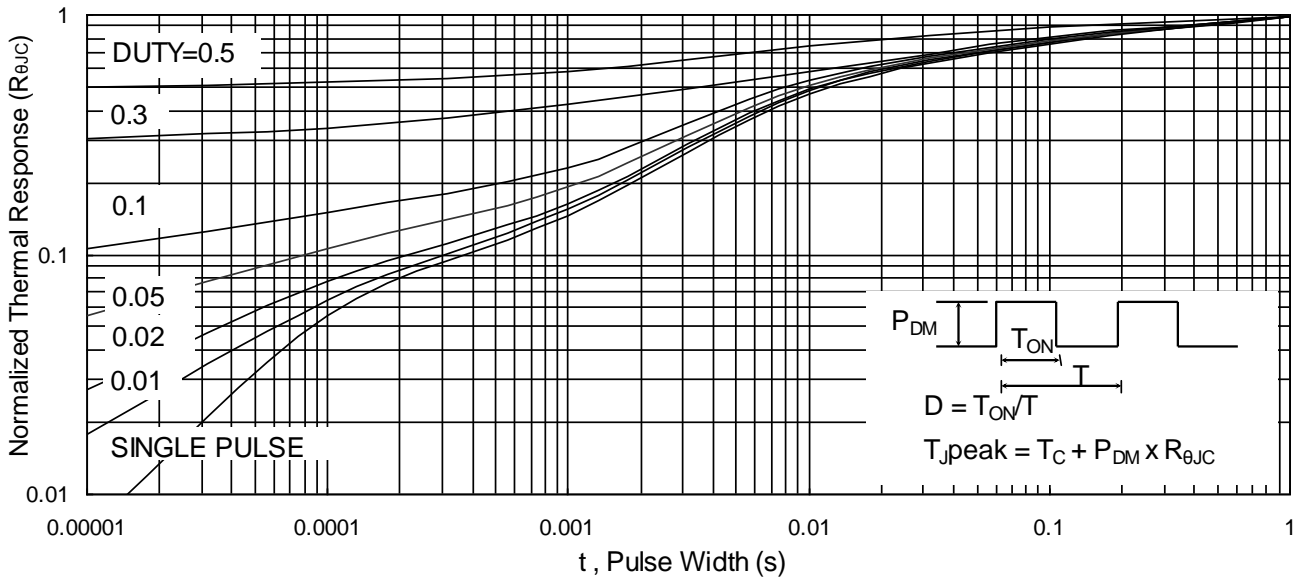

Fig.9 Normalized Maximum Transient Thermal Impedance

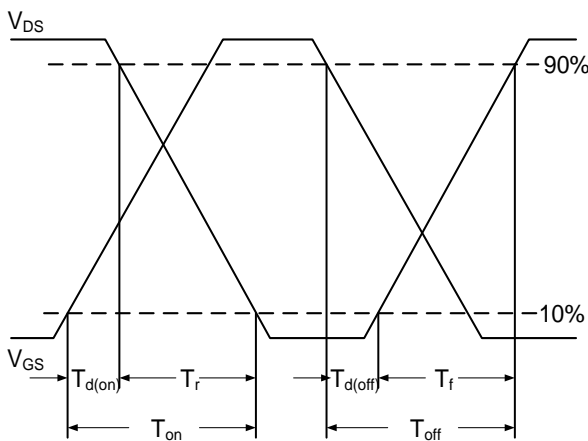

Fig.10 Switching Time Waveform

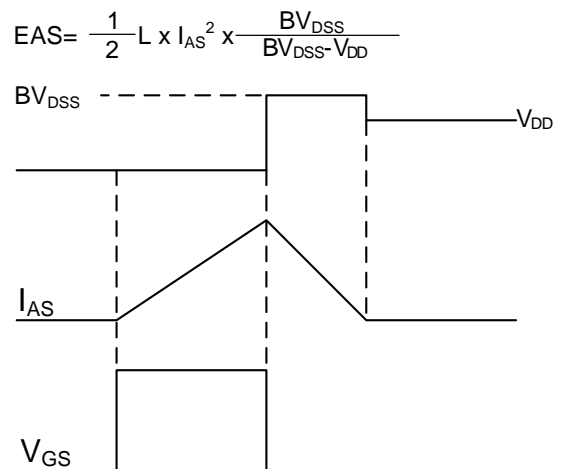
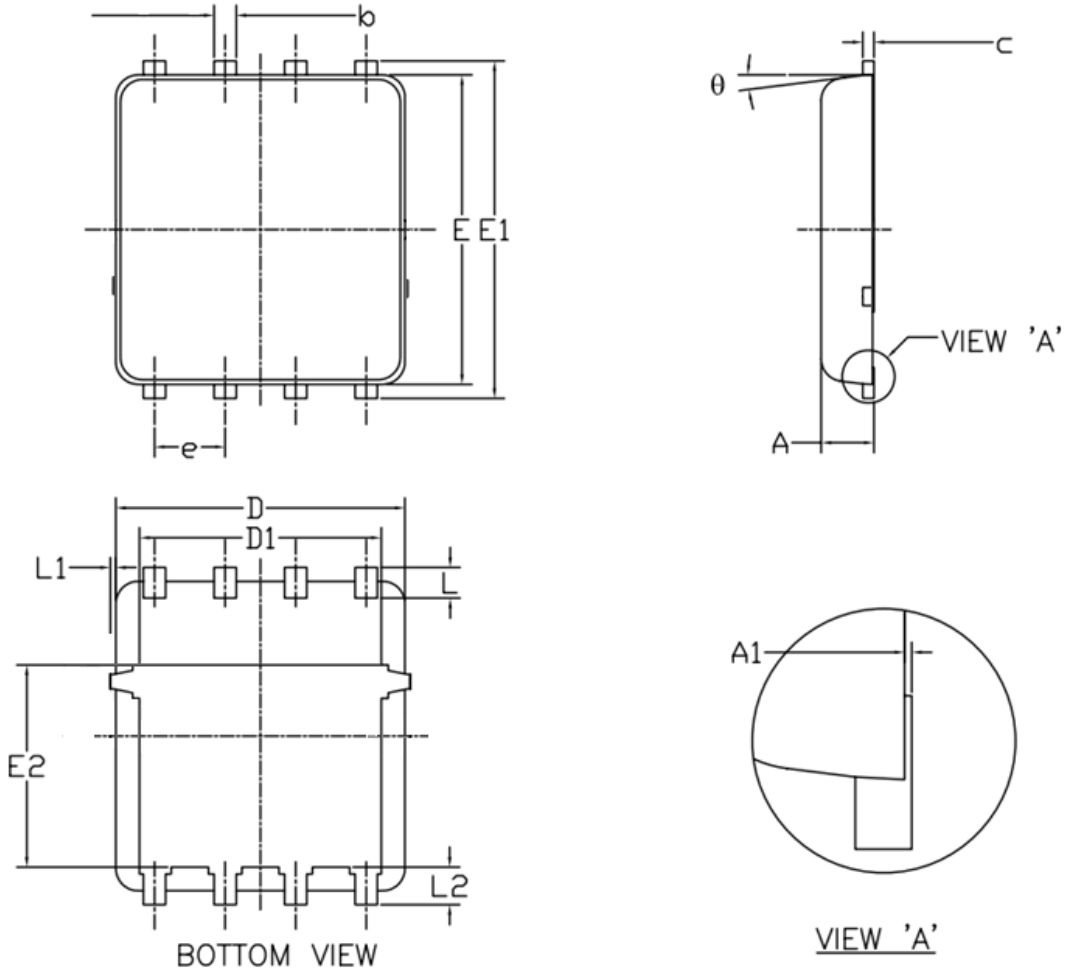

Fig.11 Unclamped Inductive Waveform

DFN5X6-8L Package Outline Dimensions



Symbol	Dimensions (unit:mm)			Symbol	Dimensions (unit:mm)		
	Min	Typ	Max		Min	Typ	Max
A	0.90	1.00	1.20	E1	5.90	6.10	6.35
A1	0.00	--	0.05	E2	3.38	3.58	3.92
b	0.30	0.40	0.51	e	1.27 BSC		
c	0.20	0.25	0.33	L	0.51	0.61	0.71
D	4.80	4.90	5.40	L1	--	--	0.15
D1	3.61	4.00	4.25	L2	0.41	0.51	0.61
E	5.65	5.80	6.06	theta	0°	--	12°